

Welcome to the Jungle

Tricia Judge, Executive Director
Int'l Imaging Technology Council

A little about the International Imaging Technology Council

International Imaging Technology Council represents the interests of the imaging supplies industry, including office-machine retail and repair, office-supply retail, computer retail, repair and networking companies, and all related industry suppliers. An estimated 2,000 domestic businesses employ some 50,000 people in the United States to recondition and repair office imaging supplies.

- Defend the industry through lobbying efforts and other industry-government programs that assist in fighting unfair competitive practices. In a recent U.S. Supreme Court case, aftermarket cartridges were the subject of unfair patent practices. (Lexmark International v. Impression Products).
- The defensive activities are not always against the OEMs either. Many of the Int'l ITC's recent activity has been against counterfeiters and manufacturers of patent-infringing clone cartridges.
- Promote the industry and its products through education of institutional buyers, government purchasers and, ultimately, consumers. Working with state and federal buyers, the Int'l ITC has brought millions of dollars in business to aftermarket dealers.
- Enhance the business of imaging supplies dealers by promoting standardized test methods and other performance-proving programs. And through the promotion of best practices, the Int'l ITC helps dealers sell more and better quality cartridges.



A little about the International Imaging Technology Council

For twenty years, the International Imaging Technology Council has administered and monitored the STMC (Standardized Test Methods Committee) program, fighting for those who use it proudly and against those who misuse it.

STMC certification proves that the company certified uses the highest industry-approved standards in manufacturing its cartridges. The STMC logo means that the cartridge in the box has been remanufactured by a company that cares about quality.

STMC is a global committee formed to find and promote standardized test methods for the printer cartridge industry. Customers demand STMC.

Look for this mark.

- For more information, see www.i-itc.org.



Legal Disclaimer

- I have thousands of hours representing and advocating for the remanufacturing industry over 23 years.
- I have written hundreds of articles about the cartridge industry's legal issues, societal concerns and political activities.
- HOWEVER, I am neither a genius nor do I have a crystal ball.
- I will set forth the legal issues and law as I understand them to be.
- I will set forth the technological impediments as I have been told they are.
- Therefore I am rendering my opinion in this presentation. These are my suggestions only.



**At Washington D.C. meeting of
Owners Rights Initiative advocates**

Legal Issues & History

- The right to repair doctrine has long protected remanufactured cartridges from claims of patent infringement. The consumer has a right to repair his car, computer and cartridge. The issue was well-settled in the mid 1990s in a variety of U.S. lawsuits.
- The OEMs tried a variety of clever marketing schemes to dissuade consumers from buying aftermarket products, particularly through post-sale restrictions using their intellectual property. This gave rise to a variety of lawsuits as well.
- In 2017, the cartridge remanufacturing industry presented the U.S. Supreme Court with the case that would change patent law dramatically. On May 30, the US Supreme Court decided that exhausted patent rights on products were exhausted after the first sale, whether domestically or overseas. The decision in *Impression Products, Inc. v. Lexmark International, Inc.*, written by Chief Justice Roberts, specifically involved the sale of printer cartridges.
- The decision is a slam dunk ending in favor of the aftermarket over Lexmark's return program. The industry's fight with Lexmark over these issues has gone on for two decades, as the decision was rendered within days of the twentieth anniversary of the introduction of prebate, later renamed the return program.
- As a result, cores and cartridges can be collected and remanufactured overseas for importation into the United States. While remanufactured cartridges have had legal clouds lifted, some ominous ones loom on the horizon for new-built cartridges.



Accused Cartridges on Canon's Latest Complaint Source: Actionable Intelligence

[Compatible with OEM cartridge model](#)

[Printer Model](#)

Canon cartridge 041/041 H	Canon imageCLASS 312x, 312i, and 312dn Canon i-SENSYS LBP312x, LBP312i, and LBP312dn
Canon cartridge 119/119 II	Canon imageCLASS LBP6300dn, LBP6650dn, LBP6670dn, MF5850dn, MF5880dn, MF5950dw, MF5960dn, MF6160dw, and MF6180dw
Canon cartridge 120	Canon imageCLASS D1120, D1150, D1170, D1180, D1320, D1350, and D1370
Canon cartridge 324 II	Canon imageCLASS LBP6780dn
Canon GPR-40	Canon imageRUNNER LBP3560 and LBP3580
Canon GPR-41	Canon imageRUNNER LBP3470 and LBP3480 Canon LASER CLASS 650i
HP CE255A/X	HP LaserJet P3010 HP LaserJet Pro MFP M521dn HP LaserJet Enterprise P3015d, P3015dn, P3015n, and P3015x HP LaserJet Enterprise 500 MFP M525f and M525dn HP LaserJet Enterprise Flow MFP M525c
HP CE505A	HP LaserJet P2033, P2033n, P2034, P2034n, P2035, P2035n, P2036, P2036n, P2037, P2037n, P2053d, P2053dn, P2053x, P2054d, P2054dn, P2054x, P2055, P2055d, P2055dn, P2055x, P2056d, P2056dn, P2056x, P2057d, P2057dn, and P2057x
HP CE505X	HP LaserJet P2053d, P2053dn, P2053x, P2054d, P2054dn, P2054x, P2055, P2055d, P2055dn, P2055x, P2056d, P2056dn, P2056x, P2057d, P2057dn, and P2057x
HP CF226A/CF226X	HP LaserJet Pro M402n, M402dn, M402dw, M426fdn, and MFP M426fdw
HP CF237A/X/Y/YC	HP LaserJet Enterprise Flow MFP M631h and M632z HP LaserJet Enterprise M607dn, M607n, M608dn, M608n, M608x, M609dn, M609x, MFP M631dn, MFP M631z, MFP M632fht, and MFP M632h

Canon Dongle Gear I

- All the patents in the first action brought by Canon over the dongle gear (“Dongle Gear I”) required a coupling member that was “tiltable” with respect to the OPC drum. As shown in *Figure 1* taken from Canon’s patents.

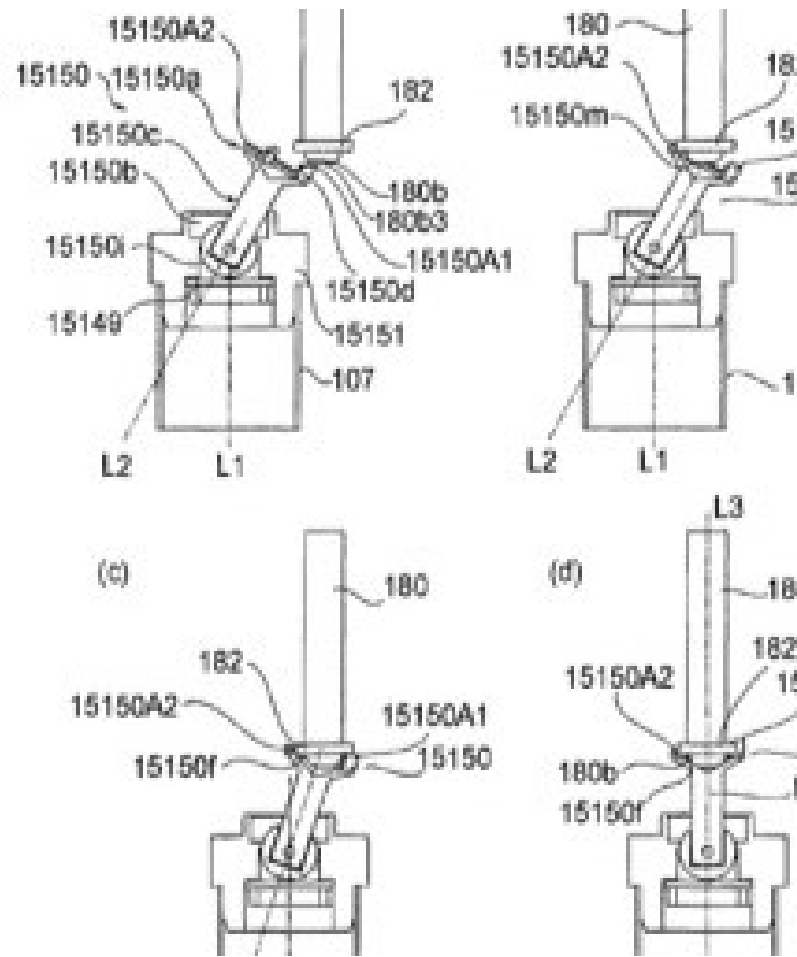

Canon Dongle Gear Workaround

- The Dongle Gear I litigation targeted copycats of the tilting dongle OEM design. In response to Dongle Gear I, the new-build cartridge manufacturers began coming up with “non-tilting” dongle gear replacements.
- These illustrations are from Print-Rite's patent.

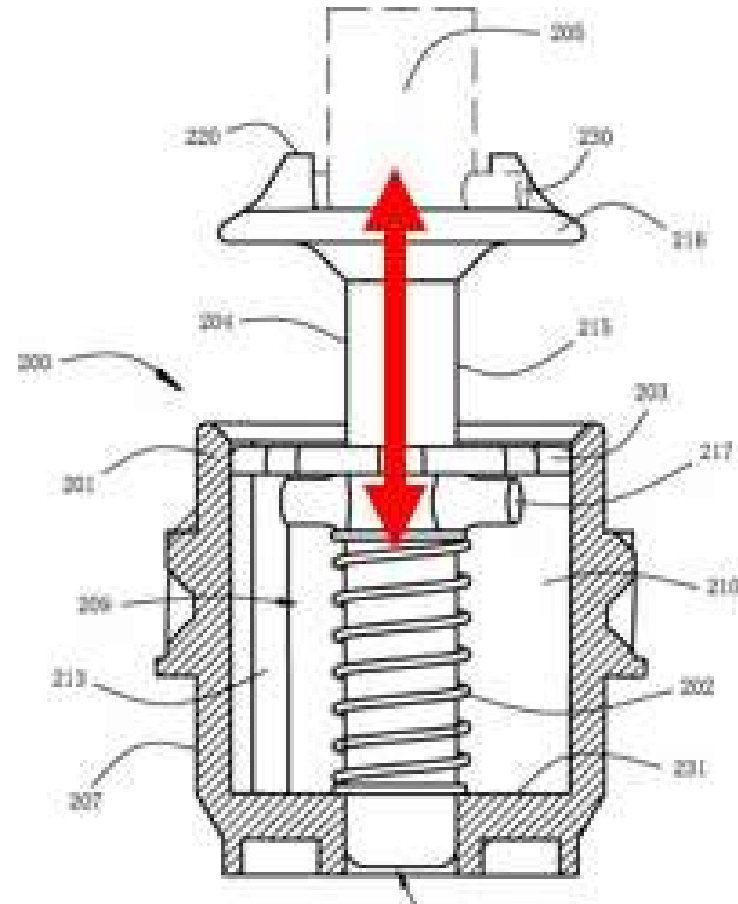

Likely Outcome of Canon Case? No Quick End in Sight

- This litigation led to a critical Markman hearing, a pretrial hearing during which the appropriate meanings of relevant key words in a patent claim are submitted by all parties to the judge for examination.
 - Canon sought to have its patents extended to all moving dongle gear configurations, while the compatible manufacturers argued that it should cover only those claims that include pivoting movement.
 - The administrative law judge and Commission's claim interpretations favored the compatible manufacturers.
 - These defendants have been quick to claim victory, but such claims are premature.
 - On May 31, 2019, Canon announced that it had appealed the ITC decision to the U.S. Federal Circuit Court of Appeals, which is one step below the U.S. Supreme Court.
 - The Federal Circuit Court will review the ITC decision from scratch, including reaching its own interpretation of Canon's claim language. Historically the Federal Circuit Court affirms only about 50% of lower court claim interpretations – at this stage the case is essentially a coin flip.
 - Canon has money and plenty of procedural avenues available.
-

Other Interesting Cases by Canon

- **Canon Sued LD Products and V4Ink for Infringement Over New-Build Color Cartridges**
 - Canon sued LD Products for patent infringement based on LD's sales of new build compatible versions of HP CF210/211/212/213 color cartridges on March 20 in a U.S. District Court in California.
 - Canon followed up the LD Products case with a similar case filed against V4Ink on May 7, 2019.
 - The patent in these cases covers "a movable member having a spacing force receiving portion capable of receiving a spacing force to space the developing roller from the photosensitive drum..."
 - This patent has been an impediment to at least one new-build Chinese manufacturer, namely Aster.
 - In a blog post ironically released the same day Canon sued LD products, Aster states: "Up to this point, Aster only provides REMANUFACTURED products compatible with HP CC530 & CB540 series, which is certainly IP compliant and in abiding with the Patent Exhaustion Doctrine. It is Aster's opinion that the available New Build Solutions do not provide clear "work around" designs to ALL patents in this patent family.... [B]ased on the broad protections illustrated above, Aster has not seen a compliant solution that is truly 'patent-safe.'"
-

Accused Cartridges in Canon's Latest Complaints

OEM Cartridge Nos.

HP CF210, CF211, CF212, CF213

Canon 116, Canon 131

OEM Printer Models

Canon imageCLASS MF8050Cn, Canon imageCLASS MF8080Cw, Canon imageCLASS LBP7110Cw, Canon imageCLASS MF624Cw, Canon imageCLASS MF628Cw, and Canon imageCLASS MF8280Cw

HP Color LaserJet CM1312 MFP, HP Color LaserJet CM1312nfi, HP Color LaserJet CP1215, HP Color LaserJet CP1515n, HP Color LaserJet CP1518ni, HP Color LaserJet CM1415fnw, and HP Color LaserJet CP1525nw

HP Color LaserJet Pro CP1525nw, HP Color LaserJet Pro 200 Color M251n, HP Color LaserJet Pro 200 Color M276n, HP Color LaserJet Pro 200 Color M251nw, and HP Color LaserJet Pro 200 Color M276nw.

New Build Compatible Cartridges

- New molded cartridges sold as “new” or even “remanufactured” at incredibly low prices.
- Many violate OEM intellectual property, as discussed previously
- The empties burden legitimate remanufacturers, who must divert them from their remanufacturing operations to comply with right to repair.
- Because they cannot be remanufactured they often end up in the landfill.
- Counterfeits: All of the OEMs have put Amazon, Ebay and others on notice.
 - ISC Raids



No shortage of Imaging Supplies Scammers

California man sentenced to 33 months; how he scammed federal government for \$3.5 million

A Granite Bay man was sentenced to 33 months in prison Monday for scamming the federal government out of \$3.5 million by switching out products he sold them for cheaper ones.

Jim A. Meron, 54, owned WOW Imaging Products LLC and Time Enterprises LLC and sold office supplies to federal agencies through two web-based government sales portals, the Department of Justice said in a news release.

Between May 2011 and July 2017, Meron used the payments from products to buy similar ones from his suppliers that “cost him a fraction of what his customers paid for the brand-name products,” according to court documents.

Meron then delivered the cheaper products to his customers and pocketed the price difference, court documents say. Over time, his scheme grew to include all the orders he received, which numbered more than 1,000, according to the court documents.

From the Sacramento Bee, June 18, 2019

- FTC’s Project BOSS, the largest fraud verdicts in U.S. history. “Catch me if you can?”
- If it looks too good to be true, don’t do it.



Now more than ever, OEMs want their supplies business back

OEM v. Aftermarket

- Adversarial relationship
- Legal challenges
- Lost sales to the Aftermarket
 - Economy driving consumers to lower cost alternatives.
 - Environmental benefits sell.
- Lost sales to China

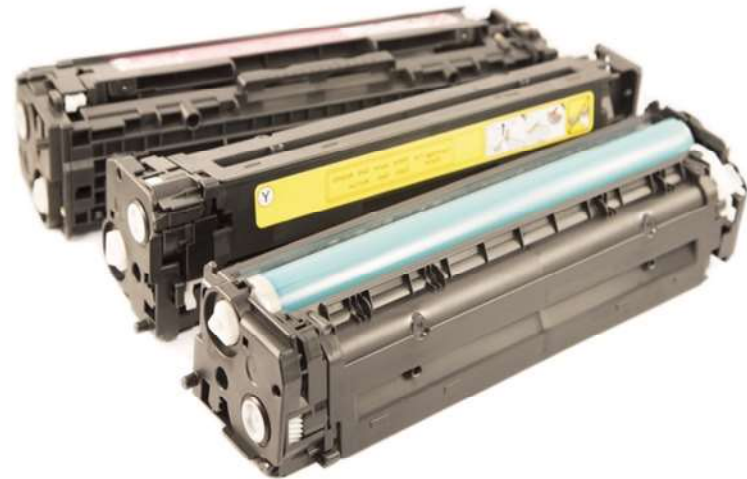

One Clear Outcome

- Remanufactured versions of these cartridges remain the safe, legal alternative, thanks to the right to repair. OEMs have hundreds of patents at their disposal covering nearly every cartridge they offer: Canon in particular has a huge patent portfolio that it has recently started to aggressively protect through litigation. It is all but impossible for a new-build manufacturer to successfully work around all those patents.



More Cases for Remanufactured: Quality

- The remanufactured cartridge is based on the reuse of the OEM core, or cartridge shell. NBCs have cores that are newly-molded plastics. New molds use inferior grade plastics that don't have the durability or integrity of OEM plastics.
- Beyond the cartridge shell, there are important technologies that the domestic market took decades to command, and then there are the chips and other highly technical components.
- A US\$3 cartridge can't address these issues with the requisite quality, nor can it have all the vetting necessary to be "IP-free."



ANY Firmware Change- Educate the Customer

- **What to do when the Upgrade is a downgrade:**
- Educate your customer about the dangers of accepting an upgrade. If they enjoy your first-class cartridges, then that upgrade could be a downgrade. If the customer is happy with the machine and its performance with remanufactured cartridges, then they must know of this threat. This is an awareness campaign.
- If an OEM representative makes the firmware upgrade sound enticing, then encourage the customers to protect themselves. The customer should insist that the OEM representative be willing to give the customer a letter on its letterhead that it will not interfere with aftermarket cartridges.
- If the new firmware results in any restriction of the customer's ease of use of an aftermarket cartridge. The customer, with his cartridge dealer's assistance, should demand that the OEM representative reverse the firmware. If that cannot be done, the OEM representative should replace the printer.



Health & Safety Issues of New-Build Cartridges: Asian Toner

- Toner consists of pigment, polymer, wax, charge control agent, bulk additives and surface additives.
- lower-cost raw materials are likely to contain "impurities" that could possibly be undesirable from a health and safety perspective. One category of the materials of concern include Volatile Organic Compounds (VOC)
- Such materials can be released into the office environment during the fusing/fixing stage of the print process. As the toner that is transferred from the photoconductor to the paper or other substrate is heated reaching 130 to 180°C, any VOC content of the toner is volatilized and exhausted from the print engine by the machine cooling system through the fan and duct to the space in which it is being operated.

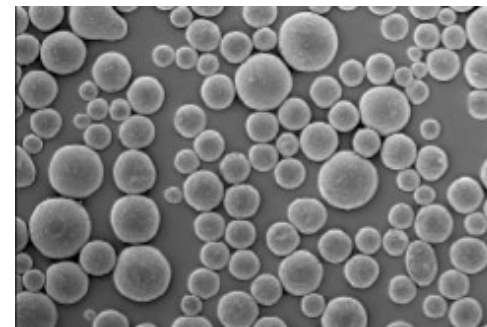
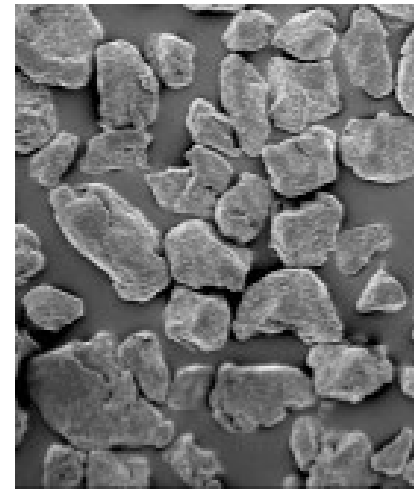

Health & Safety Issues of New-Build Cartridges: Asian Toner

- Toner dust and loose toner surface additives.
- All toners comprise finely divided particles that have a mean particle size of anywhere from five to ten microns. Toner can contain particles of size well below five microns and well above ten microns.
- Hazardous particulate size is primarily less than five microns, In addition, the surface additives that are used to promote toner powder flow, durability and charging are considerably smaller.

The scanning electron microscope (SEM) picture right shows surface additives as very small white dots on the toner particle.

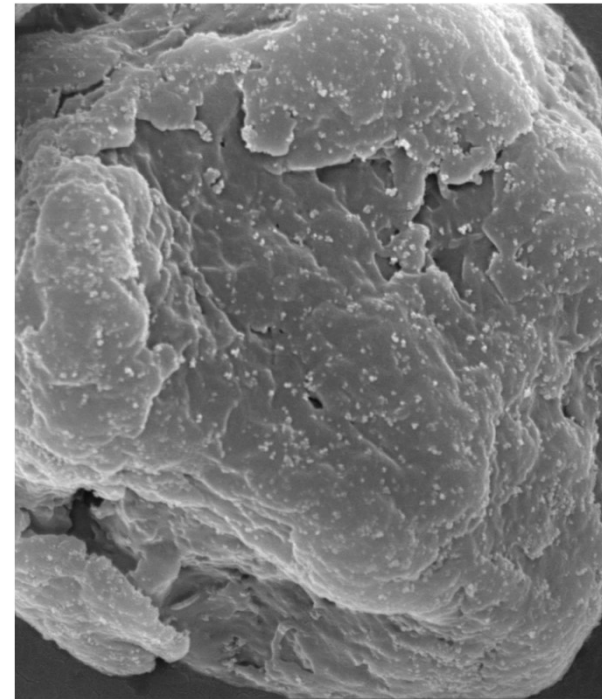

Health & Safety Issues of New-Build Cartridges – Toxins in the Plastic Core

- ETIRA report found large quantities of the flame retardant in new-built cartridge bodies.
- DecaBDE is banned in most European countries and several US states.
- It's a known carcinogen so powerful the largest commercial producers and suppliers of decabrominated diphenyl ether in the United States [agreed to phase out use of the chemical by the end of 2013](#).
- In the electrophotographic process, internal elements of the cartridge heat up to 130 to 180°C, heating the DecaBDE-laden cartridge and potentially releasing these chemicals.



Health & Safety Issues of New-Build Cartridges – Toxins in the Plastic Core



[Printers & Supplies](#) | [Solutions & Services](#) | [Customer support](#)

Why risk your health to save money?

Xerox and the other OEMs are wasting no time spreading the word.



 [Tweet](#)

 [Share](#)

 [Link](#)

Why risk your health to save money?

Volatile organic compound styrene is up to 16,510% higher in third-party, bargain-brand toner cartridges

VOCs up to 16,510 percent HIGHER in New-Builds

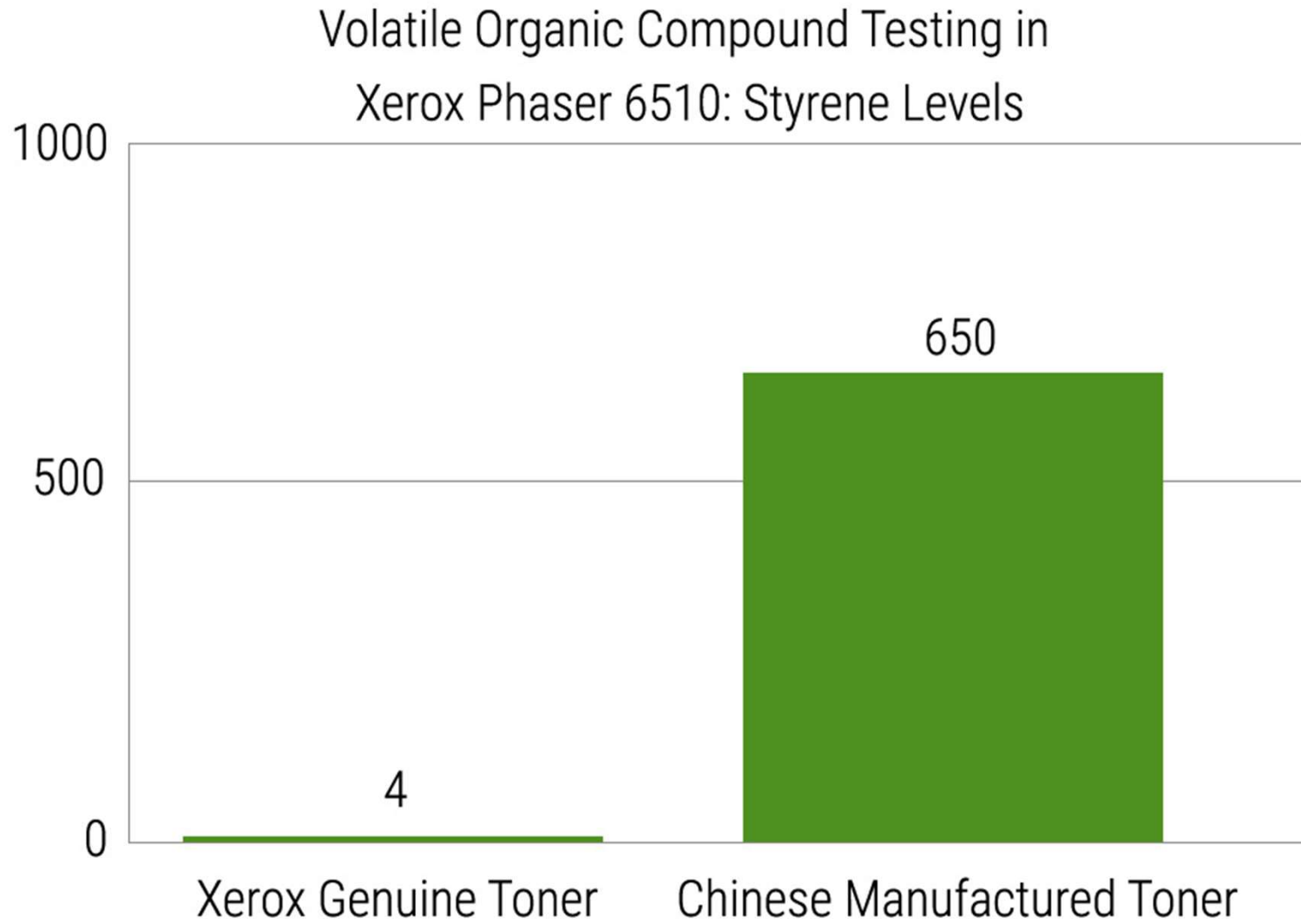

More Cases for Remanufactured: Environmental Benefits

- Environmental benefits before new-build influx:
- 27 million pounds (12.3 million kgs) industrial grade plastic reused. 73 million quarts oil (69.5 million liters) conserved.
- Clover alone reclaims more than 21 million ink and toner cartridges each year
- China has a poor track record on pollution, and the government is trying to reverse the trend.
- Since June of 2017, China's new Ministry of Environment is taking a hard stance against Chinese factories that are 'heavy polluters', " "In fact, in the most recent round of factory audits, China's environmental crackdown has shut down tens of thousands of Chinese factories
- Reman Day has taken off under the tutelage of the RIC. John Deere, Caterpillar, and 73,000 offices.
- This year's events encompassed nearly 200 locations spanning 21 countries on all six inhabited continents. Celebrations were not only global but included participation from the entirety of the remanufacturing industry -- all 12 of the recognized sectors of remanufacturing were involved. A Resolution from the U.S. House of Representatives and Proclamations from State and Local government officials were signed, formally establishing April 11, 2019 as Reman Day.

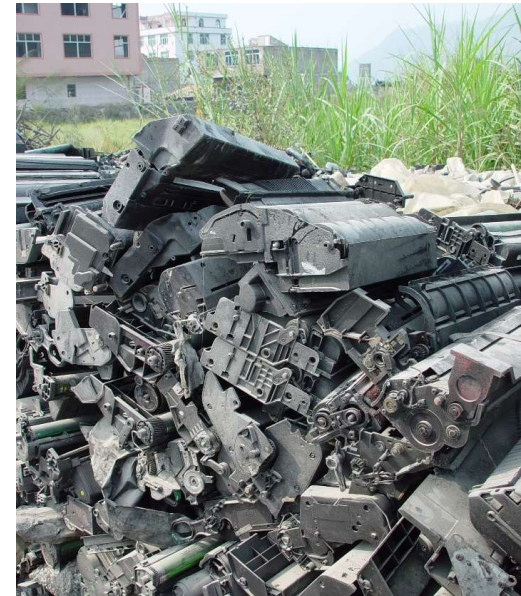

Trump's Trade War with China



- Trump has continued to implement tariffs on more and more Chinese products.
 - When the latest round of tariffs announced in early May go into effect, all Chinese made cartridges will be subject to a 25% tariff.
-



- Canon gets its GEO and importation of your NBCs ceases?
- The Chinese government shuts down your supplier?
- The U.S. refuses importation of your suppliers' cartridges?
- Or a NBC doesn't fit into your customers' printers?
- Or the quality of the cartridges you sell are surreptitiously checked, and the news is really bad?
- Trump's tariffs increase your prices by 25 percent?

You've locked into the lower-priced cartridges, and as a result, your business' future may hang in the balance.

Back up your offerings with some remanufactured cartridges. The upside? You get your margins back!



Tricia Judge
Executive Director

International Imaging Technology Council
tricia@i-itc.org